



SAW multimedia filters

Series/Type: X7261X

The following products presented in this data sheet are being withdrawn.

Ordering Code	Substitute Product	Date of Withdrawal	Deadline Last Orders	Last Shipments
B39362X7261X400		2011-01-14	2011-09-30	2012-09-30

For further information please contact your nearest EPCOS sales office, which will also support you in selecting a suitable substitute. The addresses of our worldwide sales network are presented at www.epcos.com/sales.



SAW Components

X 7261 X

SAW bandpass filter

36.17 MHz

Data Sheet

Application

- IF filter for digital TV
- Switchable between usable bandwidths 8.0MHz and 7.0MHz
- Constant group delay



Features

- Duroplast ackage **SIP5D**
- Standard IC package
- Approximate weight 0.5 g
- RoHS compatible
- Tinned CuFe alloy terminals

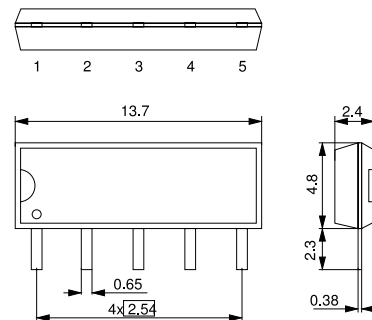

Pin configuration

- 1 Input
- 2 Switching input
- 3 Chip carrier - ground
- 4 Output
- 5 Output

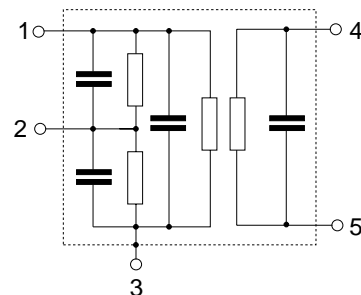

Please read *cautions and warnings and important notes* at the end of this document.



SAW Components	X 7261 X
SAW bandpass filter	36.17 MHz

Data Sheet

Characteristics of channel 1 (switching pin 2 connected to ground)

Reference temperature: $T_A = 25 (45) \text{ }^\circ\text{C}$
 Terminating source impedance: $Z_S = 50 \text{ } \Omega$
 Terminating load impedance: $Z_L = 2 \text{ k}\Omega \parallel 3 \text{ pF}$

		min.	typ. @ 25 °C	max.	
Center frequency (center between 10 dB points)	f_C	—	36.22	—	MHz
Insertion attenuation Reference level for 36.22 (36.17) MHz the following data	α	21.1	22.6	24.1	dB
Pass bandwidth					
$\alpha_{rel} \leq 1.5 \text{ dB}$	$B_{1.5dB}$	—	7.5	—	MHz
$\alpha_{rel} \leq 3 \text{ dB}$	B_{3dB}	—	7.9	—	MHz
$\alpha_{rel} \leq 15 \text{ dB}$	B_{15dB}	—	9.0	—	MHz
$\alpha_{rel} \leq 30 \text{ dB}$	B_{30dB}	—	9.7	—	MHz
Relative attenuation	α_{rel}				
32.22 (32.17) MHz		—	3.2	—	dB
32.72 (32.67) MHz		—	0.3	—	dB
39.72 (39.67) MHz		—	0.7	—	dB
40.22 (40.17) MHz		—	4.3	—	dB
Lower sidelobe 25.05 ... 31.20 (25.00 ...31.15) MHz		30.0	36.0	—	dB
Upper sidelobe 41.20 ... 42.05 (41.15 ...42.00) MHz		34.0	40.0	—	dB
42.05 ... 45.05 (42.00 ...45.00) MHz		32.0	37.0	—	dB
Reflected wave signal suppression 1.3 μs ... 6.0 μs after main pulse (test pulse 250 ns, carrier frequency 36.22 MHz)		36.0	46.0	—	dB
Group delay ripple (p-p) 32.20 ... 40.20 (32.15 ...40.15) MHz	$\Delta\tau$	—	70	—	ns
Impedance at 36.22 MHz					
Input: $Z_{IN} = R_{IN} \parallel C_{IN}$		—	3.2 \parallel 10.9	—	$\text{k}\Omega \parallel \text{pF}$
Output: $Z_{OUT} = R_{OUT} \parallel C_{OUT}$		—	4.4 \parallel 2.9	—	$\text{k}\Omega \parallel \text{pF}$
Temperature coefficient of frequency	TC_f	—	-72	—	ppm/K



SAW Components	X 7261 X
SAW bandpass filter	36.17 MHz

Data Sheet

Characteristics of channel 2 (switching pin 2 connected to pin 1)

Reference temperature: $T_A = 25 (45) \text{ }^\circ\text{C}$
 Terminating source impedance: $Z_S = 50 \text{ } \Omega$
 Terminating load impedance: $Z_L = 2 \text{ k}\Omega \parallel 3 \text{ pF}$

		min.	typ. @ 25 °C	max.	
Center frequency (center between 10 dB points)	f_C	—	36.22	—	MHz
Insertion attenuation Reference level for 36.22 (36.17) MHz the following data	α	19.7	21.2	22.7	dB
Pass bandwidth					
$\alpha_{rel} \leq 1.5 \text{ dB}$	$B_{1.5dB}$	—	6.5	—	MHz
$\alpha_{rel} \leq 3 \text{ dB}$	B_{3dB}	—	6.8	—	MHz
$\alpha_{rel} \leq 15 \text{ dB}$	B_{15dB}	—	8.0	—	MHz
$\alpha_{rel} \leq 30 \text{ dB}$	B_{30dB}	—	8.5	—	MHz
Relative attenuation	α_{rel}				
32.72 (32.67) MHz		—	3.2	—	dB
33.39 (33.34) MHz		—	0.0	—	dB
39.05 (39.00) MHz		—	0.0	—	dB
39.62 (39.57) MHz		—	4.0	—	dB
Lower sidelobe 25.05 ... 31.70 (25.00 ...31.65) MHz		28.0	33.0	—	dB
Upper sidelobe 40.80 ... 42.55 (40.75 ...42.50) MHz		28.0	34.0	—	dB
42.55 ... 45.05 (42.55 ...45.00) MHz		30.0	36.0	—	dB
Reflected wave signal suppression 1.3 μs ... 6.0 μs after main pulse (test pulse 250 ns, carrier frequency 36.22 MHz)		—	48.0	—	dB
Group delay ripple (p-p) 32.82 ... 39.72 (32.67 ...39.67) MHz	$\Delta\tau$	—	60	—	ns
Impedance at 36.22 MHz					
Input: $Z_{IN} = R_{IN} \parallel C_{IN}$		—	1.9 \parallel 14.3	—	$\text{k}\Omega \parallel \text{pF}$
Output: $Z_{OUT} = R_{OUT} \parallel C_{OUT}$		—	4.4 \parallel 2.9	—	$\text{k}\Omega \parallel \text{pF}$
Temperature coefficient of frequency	TC_f	—	-72	—	ppm/K



SAW Components

X 7261 X

SAW bandpass filter

36.17 MHz

Data Sheet

Maximum ratings

Operable temperature range	T	-25 / +65	°C	
Storage temperature range	T _{stg}	-40 / +85	°C	
DC voltage	V _{DC}	5	V	between any terminals
AC voltage	V _{pp}	10	V	between any terminals



SAW Components

X 7261 X

SAW bandpass filter

36.17 MHz

Data Sheet

Frequency response of channel 1

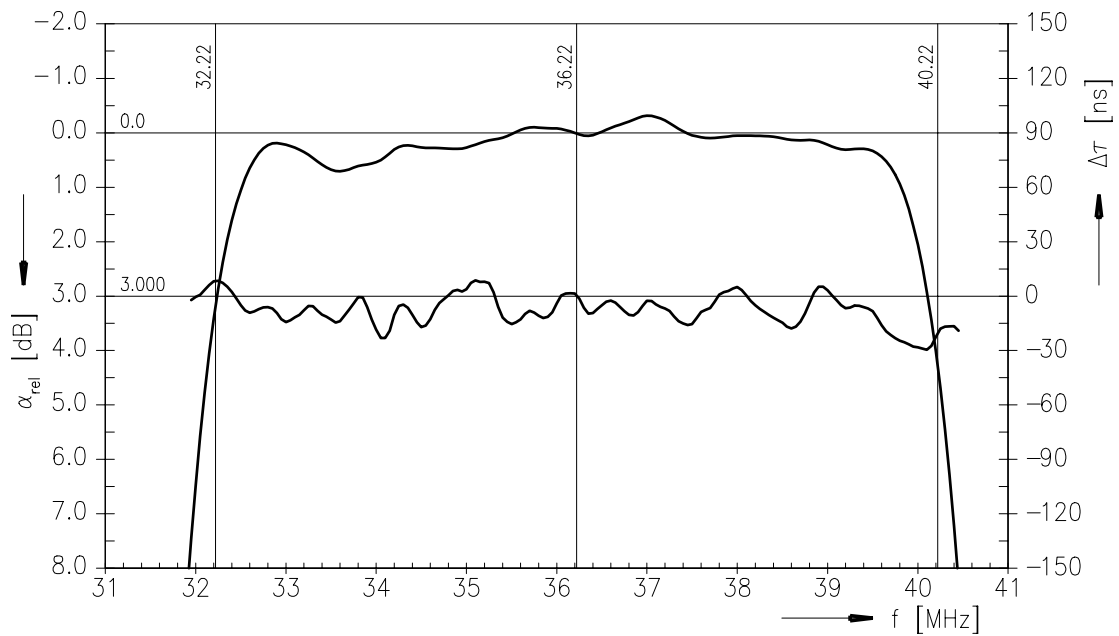
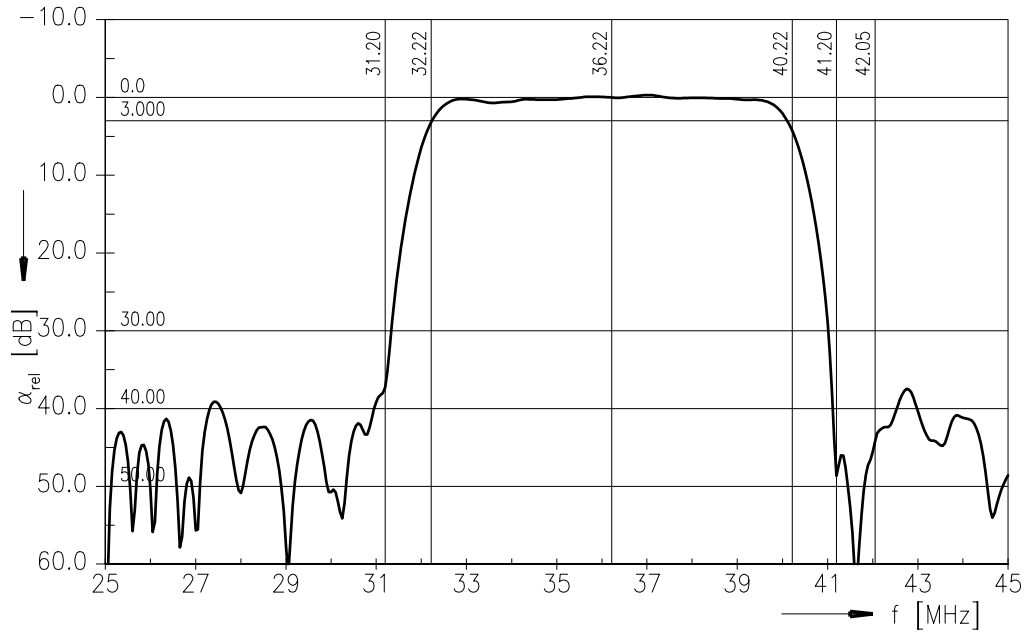

Please read *cautions and warnings* and *important notes* at the end of this document.



SAW Components

X 7261 X

SAW bandpass filter

36.17 MHz

Data Sheet

Frequency response of channel 1

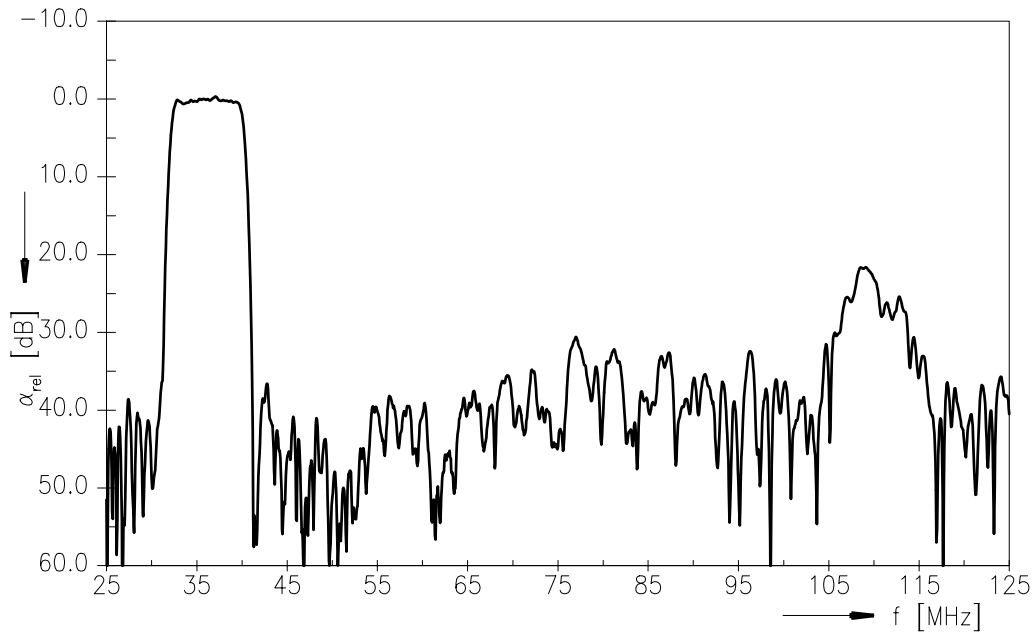

Time domain response of channel 1

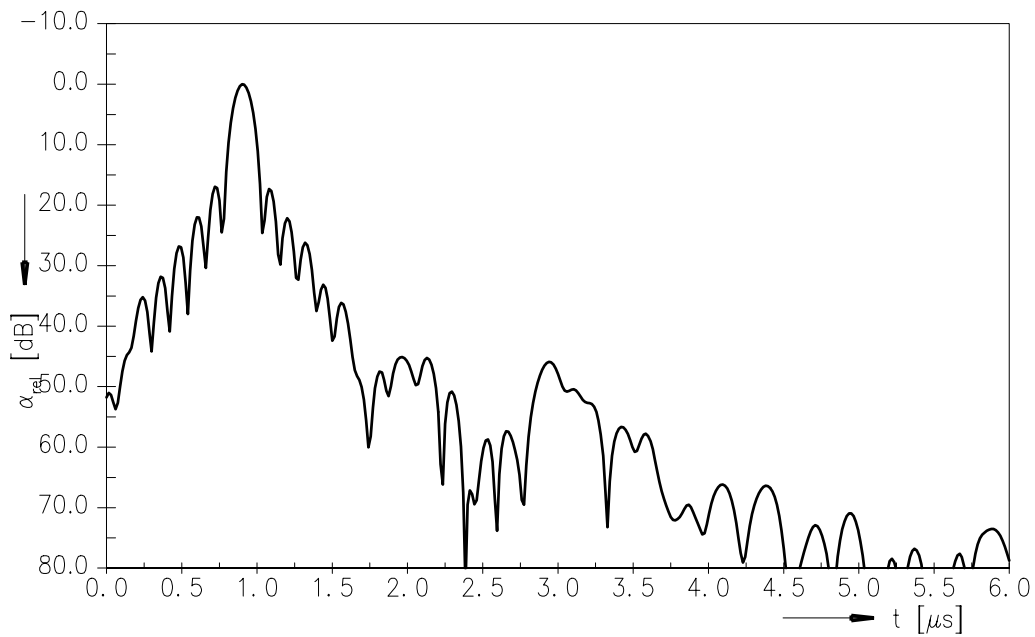

Please read *cautions and warnings* and *important notes* at the end of this document.



Data Sheet

Frequency response of channel 2

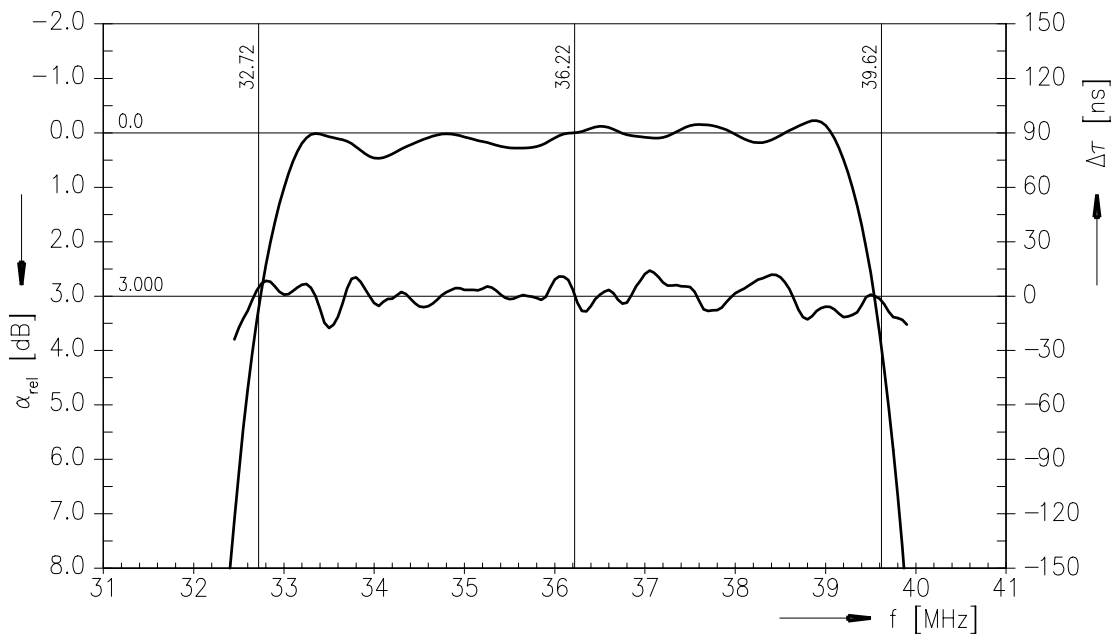
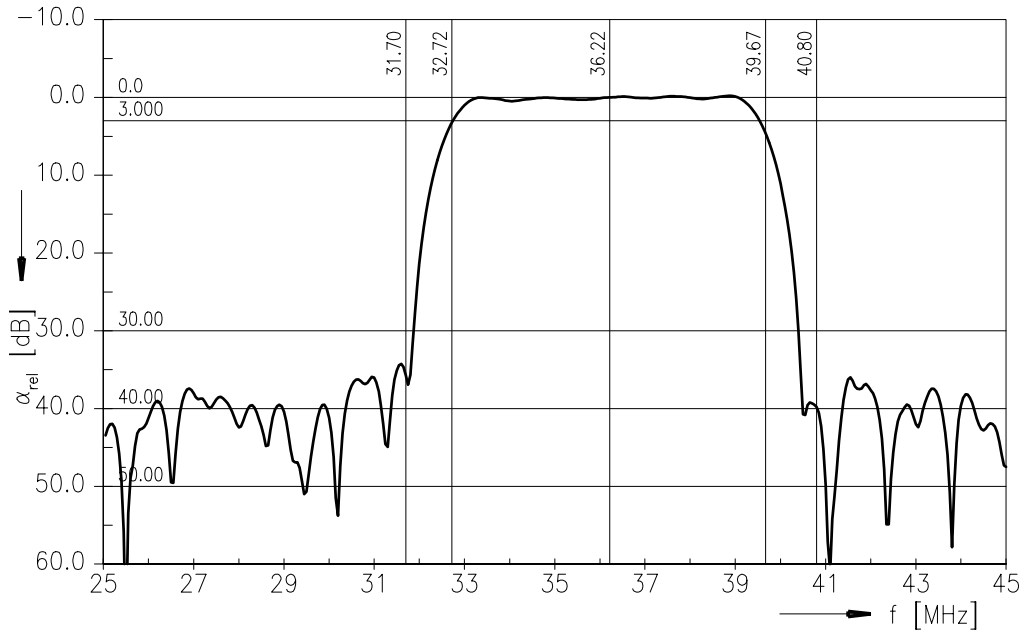



SAW Components

X 7261 X

SAW bandpass filter

36.17 MHz

Data Sheet

Frequency response of channel 2

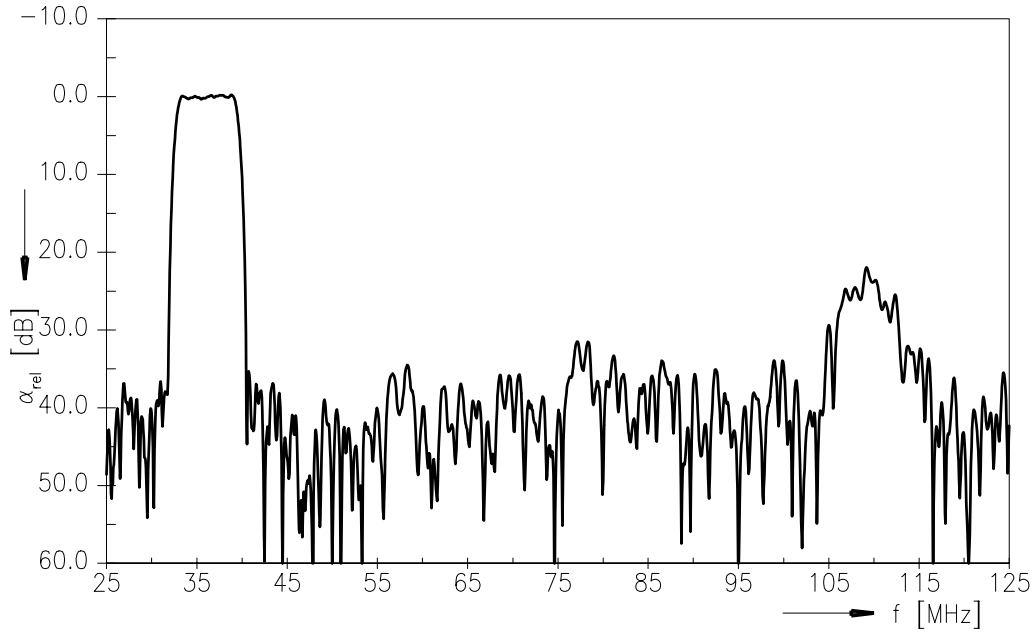

Time domain response of channel 2

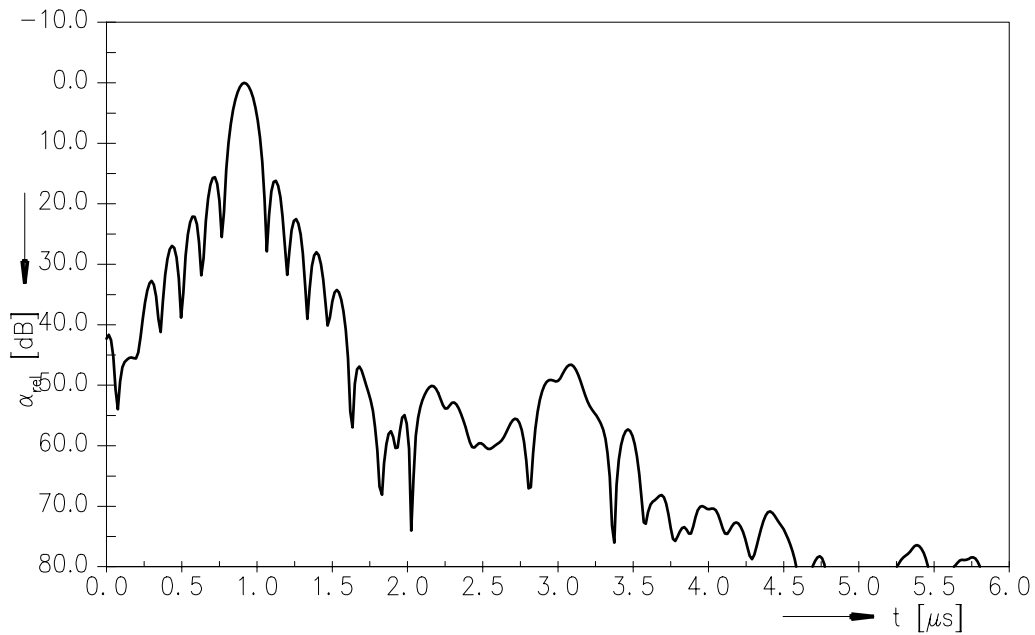

Please read *cautions and warnings* and *important notes* at the end of this document.



SAW Components	X 7261 X
SAW bandpass filter	36.17 MHz

Data Sheet

References

Type	X 7261 X
Ordering code	B39362-X7261-X400
Marking and package	C61157-A1-A22
Packaging	F61074-V8049-Z000
Date codes	L_1126
S-parameters	X7261X_NB.s4p
Soldering profile	S_6001
RoHS compatible	defined as compatible with the following documents: "DIRECTIVE 2002/95/EC OF THE EUROPEAN PARLIAMENT AND OF THE COUNCIL of 27 January 2003 on the restriction of the use of certain hazardous substances in electrical and electronic equipment. 2005/618/EC from April 18th, 2005, amending Directive 2002/95/EC of the European Parliament and of the Council for the purposes of establishing the maximum concentration values for certain hazardous substances in electrical and electronic equipment."

For further information please contact your local EPCOS sales office or visit our webpage at www.epcos.com.

Published by EPCOS AG
Surface Acoustic Wave Components Division
P.O. Box 80 17 09, 81617 Munich, GERMANY

© EPCOS AG 2008. This brochure replaces the previous edition.

For questions on technology, prices and delivery please contact the Sales Offices of EPCOS AG or the international Representatives.

Due to technical requirements components may contain dangerous substances. For information on the type in question please also contact one of our Sales Offices.

Please read *cautions and warnings and important notes* at the end of this document.



Important notes

The following applies to all products named in this publication:

1. Some parts of this publication contain **statements about the suitability of our products for certain areas of application**. These statements are based on our knowledge of typical requirements that are often placed on our products in the areas of application concerned. We nevertheless expressly point out **that such statements cannot be regarded as binding statements about the suitability of our products for a particular customer application**. As a rule, EPCOS is either unfamiliar with individual customer applications or less familiar with them than the customers themselves. For these reasons, it is always ultimately incumbent on the customer to check and decide whether an EPCOS product with the properties described in the product specification is suitable for use in a particular customer application.
2. We also point out that **in individual cases, a malfunction of electronic components or failure before the end of their usual service life cannot be completely ruled out in the current state of the art, even if they are operated as specified**. In customer applications requiring a very high level of operational safety and especially in customer applications in which the malfunction or failure of an electronic component could endanger human life or health (e.g. in accident prevention or life-saving systems), it must therefore be ensured by means of suitable design of the customer application or other action taken by the customer (e.g. installation of protective circuitry or redundancy) that no injury or damage is sustained by third parties in the event of malfunction or failure of an electronic component.
3. **The warnings, cautions and product-specific notes must be observed.**
4. In order to satisfy certain technical requirements, **some of the products described in this publication may contain substances subject to restrictions in certain jurisdictions (e.g. because they are classed as hazardous)**. Useful information on this will be found in our Material Data Sheets on the Internet (www.epcos.com/material). Should you have any more detailed questions, please contact our sales offices.
5. We constantly strive to improve our products. Consequently, **the products described in this publication may change from time to time**. The same is true of the corresponding product specifications. Please check therefore to what extent product descriptions and specifications contained in this publication are still applicable before or when you place an order. We also **reserve the right to discontinue production and delivery of products**. Consequently, we cannot guarantee that all products named in this publication will always be available. The aforementioned does not apply in the case of individual agreements deviating from the foregoing for customer-specific products.
6. Unless otherwise agreed in individual contracts, **all orders are subject to the current version of the "General Terms of Delivery for Products and Services in the Electrical Industry" published by the German Electrical and Electronics Industry Association (ZVEI)**.
7. The trade names EPCOS, BAOKE, Alu-X, CeraDiode, CSSP, CTVS, DSSP, MiniBlue, MKK, MLSC, MotorCap, PCC, PhaseCap, PhaseMod, SIFERRIT, SIFI, SIKOREL, SilverCap, SIM-DAD, SIMID, SineFormer, SIOV, SIP5D, SIP5K, ThermoFuse, WindCap are **trademarks registered or pending** in Europe and in other countries. Further information will be found on the Internet at www.epcos.com/trademarks.